

DHK090 Series---Through Bore Slip Ring

DHK090 Description:

DHK090 product with through bore 90 mm, OD 165 mm, suitable for rotating application, support 1-120 ring, signal (2A-20A/ring).



DHK090 Customized Options:

- ◆ Inner diameter, outer diameter, length
- ◆ Working speed
- ◆ Number of paths
- ◆ Current, voltage
- ◆ Shell material and color
- ◆ Protection level
- ◆ Signal and power can be transmitted separately or mixed

DHK090 2D Standard Drawing :

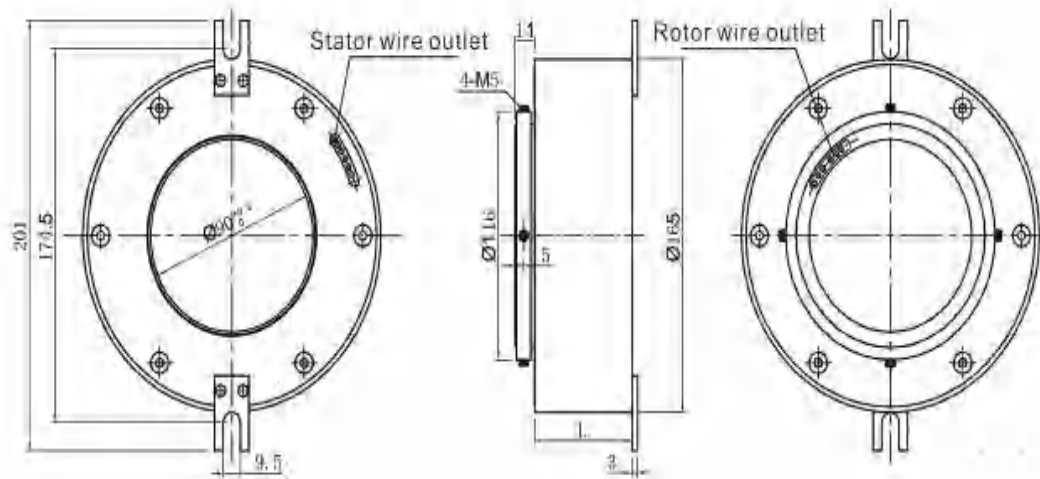

DHK090 Technical Parameters:

Product Grade Table			
Product grade	Working speed	Working life	
General	0 ~ 200 rpm	20 million revolutions	
Industrial	300 ~ 1000rpm	60 million revolutions	
Technical Parameters			
Electrical technical		Mechanical technical	
Parameters	Value	Parameters	Value
Number of rings	Custom	Working temperature	-40°C ~ +65°C
Rated current	2A,5A,10A,15A,20A	Working humidity	< 70%
Rated voltage	0 ~ 240VAC/VDC	Protection level	IP54
Insulation resistance	≥1000MΩ@500VDC	Shell material	Aluminum Alloy
Insulation strength	1500VAC@50Hz,60s,2mA	Electrical contact material	Precious metals
Dynamic resistance change value	< 10mΩ	Lead specification	Colored Teflon
Working speed	0-600rpm	Lead length	500mm+20mm

DHK090 Series Recommend Products by Ingiant

Item No.	Ring Number	2A Length	5A Length	10A Length	15A Length	20A Length	25A Length
DHK090-6	6	51	52.2	54	57	60	63
DHK090-12	12	63	65.4	69	75	81	87
DHK090-18	18	75	78.6	84	93	102	111
DHK090-24	24	87	91.8	99	111	123	135
DHK090-30	30	99	105	114	129	144	159
DHK090-36	36	111	118.2	129	147	165	183
DHK090-42	42	123	131.4	144	165	186	207
DHK090-48	48	135	144.6	159	183	207	231
DHK090-54	54	147	157.8	174	201	-	-
DHK090-60	60	159	171	189	219	-	-
DHK090-66	66	171	184.2	204	-	-	-
DHK090-72	72	183	197.4	219	-	-	-
DHK090-78	78	195	210.6	-	-	-	-
DHK090-84	84	207	223.8	-	-	-	-
DHK090-90	90	219	237	-	-	-	-
DHK090-96	96	231	250.2	-	-	-	-
DHK090-102	102	243	263.4	-	-	-	-
DHK090-108	108	255	276.6	-	-	-	-
DHK090-114	114	267	-	-	-	-	-
DHK090-120	120	279	-	-	-	-	-

Conductor Specification:2A with AWG26# color Teflon conductor ,

5A with AWG22# color Teflon conductor

10A uses AWG18#color Teflon conductor (or AWG16# flexible
color PVC insulated conductor)

15A uses AWG16# color Teflon conductor (or AWG14# flexible
color PVC insulated conductor)

20A uses AWG14# color Teflon conductor.

Length of product combinations with arbitrary number of
channels(n2,n5,n10,n15,n20)(mm):

$$L=15.4+2*n2+2.2*n5+2.5*n10+3*n15+3.5*n20$$